

Dongguan Huayu Automation Technology Co., Ltd.

东莞市华佑自动化科技有限公司

Dongguan ONCE Machinery Manufacturing Co, Ltd.

东莞市安色机械制造有限公司



安色机械[®]

ONCE

选安色, 更出色
CHOOSE ONCE, TRUST FOREVER

简介

关于 华佑自动化，安色机械

东莞市华佑自动化科技有限公司是自动化印刷设备的专业制造商。其产品包括丝网印刷机，移印机，烫金机，热转印机及相关设备，可满足各种形状和材料的印刷要求，广泛应用于日用品，食品，化妆品，医疗用品，汽车配件等领域和行业。**华佑**自动化印刷设备远销欧洲，美国，韩国，中东，南非，墨西哥等国家和地区，深受国内外客户的信赖。

东莞市安色机械制造有限公司在自动化丝网印刷机的生产中提供智能工程，智能机械和智能制造的领先技术。



目录

1

东莞市华佑自动化科技有限公司相关介绍?

2

东莞市华佑自动化科技有限公司被选择的理由?

3

东莞市华佑自动化及安色机械所生产印刷机系列?

4

东莞市华佑自动化科技有限公司优质的目标客户群?

5

东莞市华佑自动化科技有限公司印刷设备的应用领域?

6

东莞市华佑自动化科技有限公司涉及的展会及社交媒体?



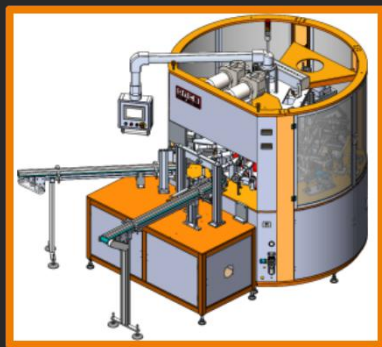

东莞市华佑自动化科技有限公司

相关介绍

关于我们

东莞市华佑自动化科技有限公司是自动化印刷设备的专业制造商。其产品包括丝网印刷机，移印机，烫金机，热转印机及相关设备，可满足各种形状和材料的印刷要求，广泛应用于日用品，食品，化妆品，医疗用品，汽车配件等领域和行业。**华佑**自动化印刷设备远销欧洲，美国，韩国，中东，南非，墨西哥等国家和地区，深受国内外客户的信赖。

东莞市安色机械制造有限公司在自动化丝网印刷机的生产中提供智能工程，智能机械和智能制造的领先技术。



企业构架

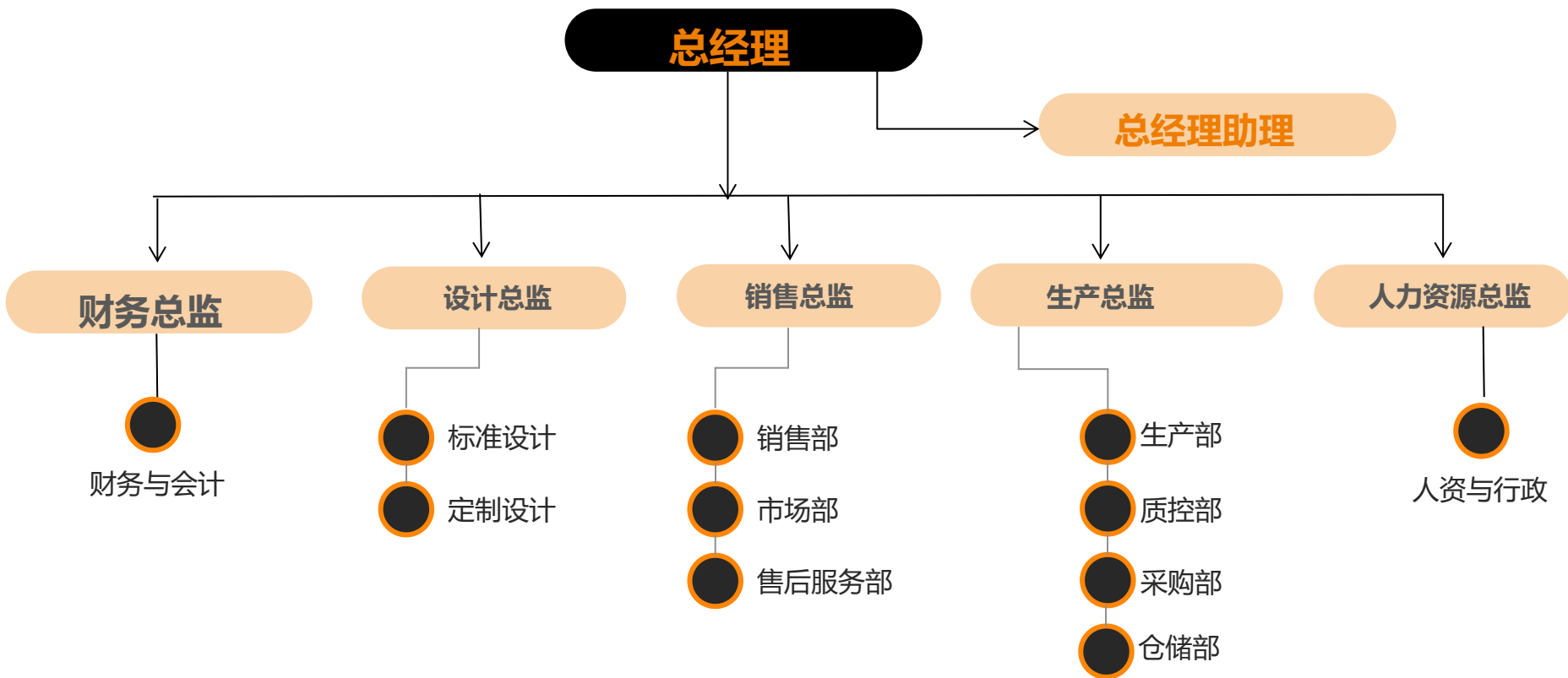

工厂概况



标准机组装



定制机组装



半成品加工区



待定区



成品机仓库



原料仓库



样机检查与测试



电气设备区

车间概况



CNC机械加工区



CNC机械加工区



非标机区

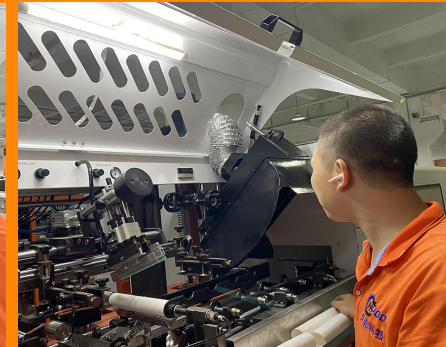

标准机区



电气设备区



组装区



调试区



调试区

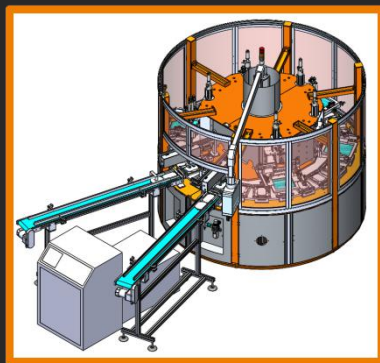

东莞市华佑自动化科技有限公司 被选择的理由

--- 自动化圆状品丝网印刷机生产制造商

营业执照

编号: N^o 0733473

营业执照
(副本) (副本号:1-1)

统一社会信用代码 91441900056795850P

名称 东莞市安色机械制造有限公司
类型 有限责任公司(自然人投资或控股)
住所 东莞市常平镇桥梓村桥梓大道首长科技工业园C栋一楼中
法定代表人 张华
注册资本 人民币壹佰万元
成立日期 2012年11月07日
营业期限 长期
经营范围 产销、制造:通用机械设备、包装机械、塑胶专用设备。
(依法须经批准的项目,经相关部门批准后方可开展经营活动。)

登记机关  2016年8月1日

企业信用信息公示系统网址: <http://gsxt.gdgs.gov.cn/> 中华人民共和国国家工商行政管理总局监制



安色机械 营业执照

统一社会信用代码 91441900MA4W0Y3PX9

营业执照

名称 东莞市华佑自动化科技有限公司
类型 有限责任公司(自然人投资或控股)
法定代表人 张华
经营范围 研发、产销:自动化机械设备、机电设备、包装机械、印刷机、塑胶专用设备;货物进出口、技术进出口。(依法须经批准的项目,经相关部门批准后方可开展经营活动。)

注册资本 人民币伍佰万元
成立日期 2016年11月28日
营业期限 长期
住所 广东省东莞市常平镇常横路144号1栋102室

登记机关  2016年11月28日

请于每年6月30日前报送年度报告,逾期将受到信用惩戒和处罚。
途径:登录企业信用信息公示系统,或“东莞市场监管”微信公众号。

国家企业信用信息公示系统网址: <http://www.gsxt.gov.cn> 国家市场监督管理总局监制



扫描二维码登录“国家企业信用信息公示系统”了解更多登记、备案、许可、监管信息。

华佑自动化 营业执照

认证与专利

EST Standard Testing & Certification

Certificate of Conformity
According to Machinery Directive 2006/42/EC
Certificate No.: ESTSZ141003227M

Applicant : Once Machinery Manufacturing Co., LTD
Building C, Shouzhong S&T Zone, Qiaozhi Avenue Changping, Dongguan City, Guangdong Province

Manufacturer : Once Machinery Manufacturing Co., LTD
Building C, Shouzhong S&T Zone, Qiaozhi Avenue Changping, Dongguan City, Guangdong Province

Trade Mark : N/A

Product : Printing Machine

Model No. : OS-175, OS-230, OS-400, OS-416, OS-616, OS-767, OS-767XL, OS-F12, OS-R320T, OS-R45

Test Report No. : ESTSZ141003227M

Test Standard(s) : 2006/42/EC Annex I
EN ISO 12100: 2010
EN 60204-1: 2006+A1: 2009

The certificate of conformity is based on an evaluation of a sample of the above mentioned product. Technical report and documentation are at the applicant's disposal. This is to certify that the tested sample is in conformity with all revision of Annex I of Council Directive 2006/42/EC, in its latest amended version, referred to the Machinery Directive. The certificate does not imply assessment of the series-production of the product and does not permit the use of EST logo. The applicant of the certificate is authorized to use this certificate in connection with EC declaration of conformity to Annex II of the Directive.

Javier Cobin
For Chief Executive
Date of Issue: Nov. 07, 2014



The CE Marking may only be used if all relevant and effective EC Directives are complied with.

SHENZHEN EXACT STANDARD TESTING TECHNOLOGY CO., LTD.
No.403, Building 7, Ninyuan Industrial Park, Xingqiang Road, Xili, Nanshan District, Shenzhen, Guangdong, China
Tel: (86)755-26548610 Fax: (86)755-26548527 http://www.estcd.com

Page 1 of 1

CE认证

证书号第 9440176 号



实用新型专利证书

实用新型名称: 一种具有表干装置的立式转盘丝印机

发明人: 张华

专利号: ZL 2018 2 2103957.5

专利申请日: 2018年12月14日

专利权人: 东莞市安色机械制造有限公司

地址: 523000 广东省东莞市常平镇桥梓村桥梓大道首长科技工业园C栋一楼中

授权公告日: 2019年10月01日 授权公告号: CN 209454343 U

国家知识产权局依照中华人民共和国专利法经过初步审查, 决定授予专利权, 颁发实用新型专利证书并在专利登记簿上予以登记。专利权自授权公告之日起生效。专利期限为十年, 自申请日起算。

专利证书记载专利权登记时的法律状况。专利权的转移、质押、无效、终止、恢复和专利权利人的姓名或名称、国籍、地址变更等事项记载在专利登记簿上。



局长 申长雨

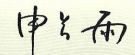



2019年10月01日

第 1 页 (共 2 页)

其他事项参见背面

产品专利

证书号第 10383499 号



实用新型专利证书

实用新型名称: 可快速二次印刷的UV丝印机

发明人: 张华

专利号: ZL 2019 2 1046363.3

专利申请日: 2019年07月06日

专利权人: 东莞市安色机械制造有限公司

地址: 523000 广东省东莞市常平镇桥梓村桥梓大道首长科技工业园C栋一楼中

授权公告日: 2020年04月24日 授权公告号: CN 210390444 U

国家知识产权局依照中华人民共和国专利法经过初步审查, 决定授予专利权, 颁发实用新型专利证书并在专利登记簿上予以登记。专利权自授权公告之日起生效。专利期限为十年, 自申请日起算。

专利证书记载专利权登记时的法律状况。专利权的转移、质押、无效、终止、恢复和专利权利人的姓名或名称、国籍、地址变更等事项记载在专利登记簿上。



局长 申长雨

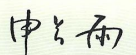



2020年04月24日

第 1 页 (共 2 页)

其他事项参见背面

产品专利

优势与强项

1

成本优势

保证质量的前提下，从首道工序至末道工序均降低原材料成本。

2

技术亮点

不仅可生产标准印刷机，还可根据客户特别要求提供定制印刷机。

3

专业营销策略

快速交期，充足库存，强大销售支持，及时销售响应，广泛海内外展览。

4

完善售后服务

专业制造商，高品质承诺，卓越技术支持，优质客户服务，双赢合作体验。



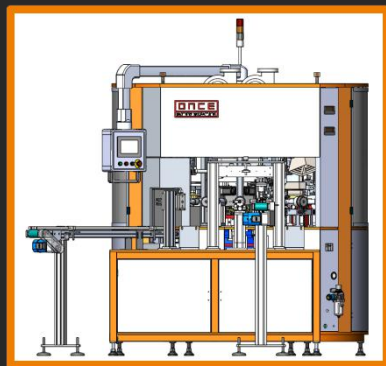

东莞市华佑自动化及安色机械 所生产印刷机系列

印刷机 --- 坚固，可靠，拓展性强，易于操作

全系列印刷机（丝网印刷）

圆柱品印刷机

圆形容器的尺寸:	直径: 10-100mm, 高度: 30-260mm
圆形容器的最大印刷尺寸范围:	长260 x 宽220mm
椭圆容器的尺寸:	长半径: 10-250mm, 高度: 30-260mm
椭圆容器的最大印刷尺寸范围:	长120 x 宽220mm

平面品印刷机

印刷产品的尺寸:	长160 x 宽160 x 高100mm
平面容器的最大印刷尺寸范围:	长110 x 宽90mm
印刷工位:	24
最快印刷速度:	45个/分钟

桶状品印刷机

桶状印刷产品的尺寸:	直径: 150-350mm, 高度: 200-400mm
最大印刷尺寸范围:	长900 x 宽250mm
火焰处理系统:	3套, 液化石油气
最快印刷速度:	25个/分钟

管状品印刷机

印刷产品的尺寸:	直径: 10mm-75mm, 高度: 20mm-230mm
最大印刷尺寸范围:	236x170mm
印刷工位:	12
最快印刷速度:	60-80个/分钟

我司在自动化丝网印刷机的生产中提供智能工程，智能机械和智能制造的领先技术。

产品列表



- OS-767-1: 全自动单色UV圆柱品丝网印刷机
- OS-767-2: 全自动两色UV瓶状品丝网印刷机
- OS-767-3: 全自动三色圆瓶丝网印刷机
- OS-767-6: 全自动五色圆瓶丝印烫金机

- OS-175: 全自动单色管状化妆品丝网印刷机
- OS-230: 全自动两色管状化妆品丝网印刷机
- OS-320: 全自动一到六色软管旋转台UV丝网印刷机
- OS-R324: 全自动三色平床丝网印刷机
- OS-T106: 全自动单色烫金机
- OS-1000: 全自动一到八色桶状品UV丝网印刷机

明星产品

OS-767

多色印刷，精准套色
全自动1-6色UV瓶状品丝网印刷机
快速打印，速度高达4200瓶/小时
圆形，椭圆形和正方形瓶上均可打印



强势标准机

OS-175



全自动单色管状化妆品丝网印刷机

OS-230



全自动两色管状化妆品丝网印刷机

强势标准机

OS-324



全自动三色平床丝网印刷机

OS-320



全自动一到六色软管旋转台UV丝网印刷机

强势标准机

OS-1000



全自动一到八色桶状品UV丝网印刷机

OS-T106



全自动单色烫金机

强势标准机

OS-324



全自动一到八色桶状品UV丝网印刷机

OS-767



全自动印刷机+贴标机

强势标准机

OS-340



压力罐专用全自动印刷机

强势定制机

OS-230



(医疗行业, 离心管专用印刷机, 配自动上料和旋盖设备)

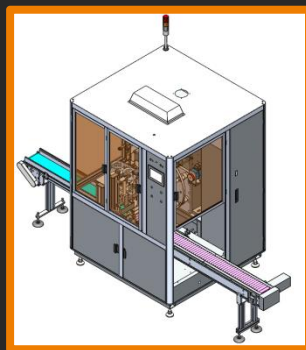

东莞市华佑自动化科技有限公司

优质的目标客户群

--- 选安色, 更出色

--- Choose ONCE, trust forever

客户国家分布



45%

超20年印刷机制造历史

我司国内分销商分布地区: 广东, 湖北, 河南, 安徽, 上海, 山东, 江苏, 浙江, 江西等城市

55%

超8年全球出口经验

我司印刷设备远销海外: 欧洲, 美国, 韩国, 日本, 中东, 南非, 墨西哥等国家及地区

客户行业分布

40%

化妆品及个人护理行业

眉笔, 口红, 笔筒, 睫毛刷, 沐浴露瓶, 洗发水瓶, 膏霜瓶和其他圆形和扁平瓶

30%

食品及饮料行业

水杯, 牛奶瓶, 咖啡杯, 茶罐, 饼干罐, 热水瓶和其他圆柱形和椭圆形容器

20%

制药业

千分表容器, PP试管, 一次性注射器, 插入管和其他试管容器

10%

化学及汽车行业

塑料瓶, 油瓶, 滤油器, 油漆桶, 油漆桶, 玻璃软管等圆形产品

经典客户品牌案例

AVON
雅芳

CARSLAN

BOSS
HUGO BOSS

CLINIQUE
倩碧

LANCÔME
PARIS
兰蔻

BIOHERM
碧欧泉

ESTÉE
LAUDER
COMPANIES

MARY KAY®
玫琳凯

Dior
迪奥

TJOY
丁家宜

Johnson's baby
强生

MAYBELLINE
美宝莲

MAC
魅可

OLAY
玉兰油

~H₂O+

apple

Calvin Klein

L'ORÉAL®

MAHLE

DELPHI

NISSAN

相宜本草
INOHERB

LOCK & LOCK

P&G

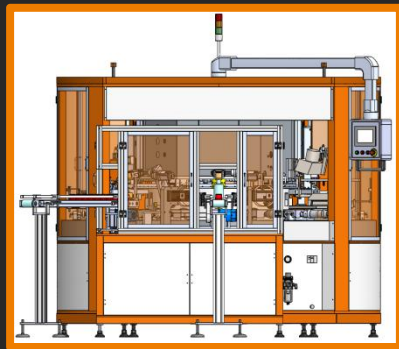

东莞市华佑自动化科技有限公司

印刷设备的应用领域

--- 我司竭诚为广大客户业务需求创建最佳印刷设备解决方案

应用类别：根据产品形状



Bottle - Round

瓶—圆形



Bottle - Flat - One Side

瓶—平形—单面



Bottle - Flat - Front and Back

瓶—平形—前后面



Bottle - Oval - Front and/or Back

瓶—椭圆形—前及(或)后



Bottle - 3-Sided - One Label

瓶—3面—1标签



Bottle - 4-Sided - One Label

瓶—4面—1标签



Product - Top Only

产品—仅顶部



Product - Bottom - With/Without Top

产品—底部—有(无)顶部



Carton, Small Box

纸箱, 小盒



Case, Carton, Corner Labeling

盒子, 纸箱, 角落贴标



Round, Tapered

圆桶, 椎形



Vial, Syringe

药水瓶, 注射器



Special Applications

特殊应用

应用类别：根据产品功能



Water Bottles

水瓶



Wine Glass Bottles

酒瓶



Personal Care

个护容器



Bucket / Pail

桶



Pharmaceutical

医药容器



Auto / Oil Bottles

汽车业/油瓶



Chemicals

化学制品



Beauty Care

美容保养



Cosmetics Bottles

瓶状化妆品



Cosmetics Tubes

管状化妆品

主要应用展示

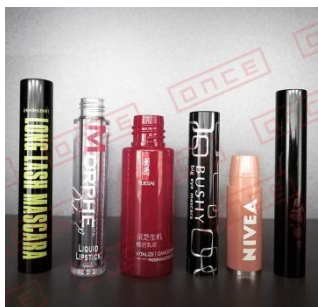

主要应用展示

HV00 华佑科技
Manufacturer of Automatic Screen Printing Machines and Hot Stamping Machines



Dongguan Huayu Automation Technology Co., Ltd www.hyoauto.com, sales@hyoauto.com

HV00 华佑科技
Manufacturer of Automatic Screen Printing Machines and Hot Stamping Machines



Dongguan Huayu Automation Technology Co., Ltd www.hyoauto.com, sales@hyoauto.com

HV00 华佑科技
Manufacturer of Automatic Screen Printing Machines and Hot Stamping Machines



Dongguan Huayu Automation Technology Co., Ltd www.hyoauto.com, sales@hyoauto.com

HV00 华佑科技
Manufacturer of Automatic Screen Printing Machines and Hot Stamping Machines



Dongguan Huayu Automation Technology Co., Ltd www.hyoauto.com, sales@hyoauto.com

HV00 华佑科技
Manufacturer of Automatic Screen Printing Machines and Hot Stamping Machines



Dongguan Huayu Automation Technology Co., Ltd www.hyoauto.com, sales@hyoauto.com

HV00 华佑科技
Manufacturer of Automatic Screen Printing Machines and Hot Stamping Machines



Dongguan Huayu Automation Technology Co., Ltd www.hyoauto.com, sales@hyoauto.com

HV00 华佑科技
Manufacturer of Automatic Screen Printing Machines and Hot Stamping Machines



Dongguan Huayu Automation Technology Co., Ltd www.hyoauto.com, sales@hyoauto.com

HV00 华佑科技
Manufacturer of Automatic Screen Printing Machines and Hot Stamping Machines



Dongguan Huayu Automation Technology Co., Ltd www.hyoauto.com, sales@hyoauto.com

HV00 华佑科技
Manufacturer of Automatic Screen Printing Machines and Hot Stamping Machines



Dongguan Huayu Automation Technology Co., Ltd www.hyoauto.com, sales@hyoauto.com

HV00 华佑科技
Manufacturer of Automatic Screen Printing Machines and Hot Stamping Machines



Dongguan Huayu Automation Technology Co., Ltd www.hyoauto.com, sales@hyoauto.com

HV00 华佑科技
Manufacturer of Automatic Screen Printing Machines and Hot Stamping Machines



Dongguan Huayu Automation Technology Co., Ltd www.hyoauto.com, sales@hyoauto.com

HV00 华佑科技
Manufacturer of Automatic Screen Printing Machines and Hot Stamping Machines



Dongguan Huayu Automation Technology Co., Ltd www.hyoauto.com, sales@hyoauto.com

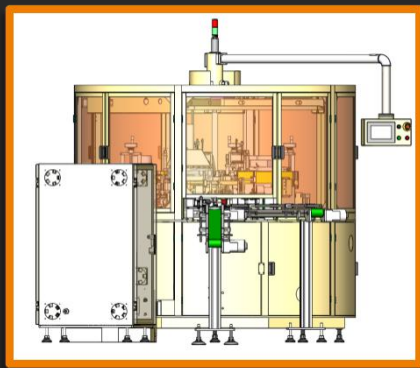

东莞市华佑自动化科技有限公司

涉及的展会及社交网络

--- 选安色, 更出色

--- Choose ONCE, trust forever

2015年-2021年展览计划

Chinaplas
国际橡塑展



Chinaplas
国际橡塑展



Chinaplas
国际橡塑展



ICMD 中国国际医疗
器械设计与制造展览



中国上海美
容博览CBE



铝门窗幕墙新
产品博览会



CMEF中国国际
医疗器械博览会



Chinaplas
国际橡塑展



2015年到2019年展览历史回顾

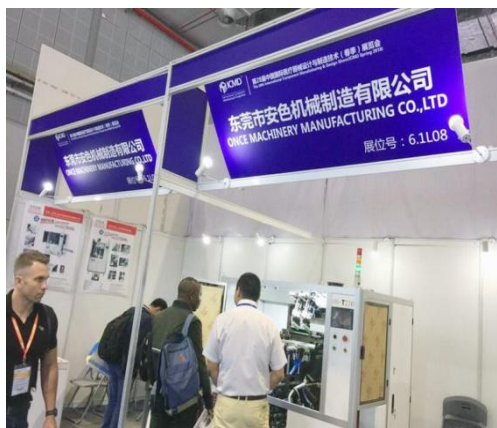
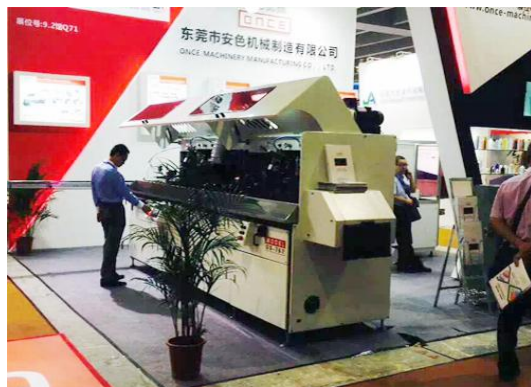

2020年第二十五届中国美容博览会（上海CBE），展位号：N3E14

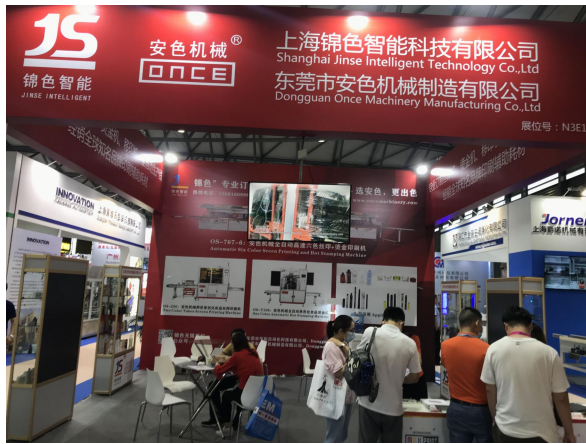

2020年第26届铝门窗幕墙新产品博览会，展位号：7K02



2020年CMEF第83届中国国际医疗器械博览会，展位号：K61

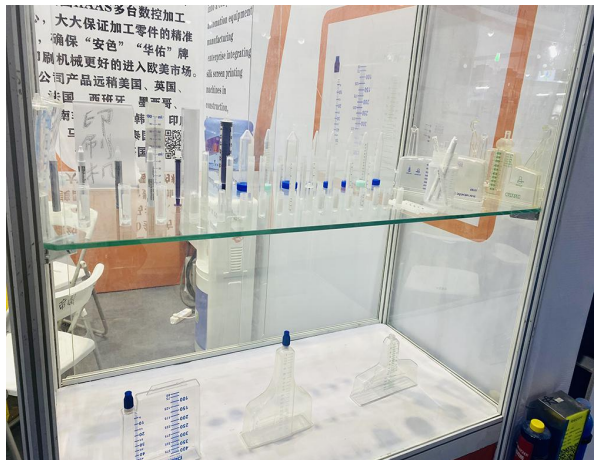

官网: www.hyooauto.com, www.oncemachinery.com

公司新闻

公司动态
行业动态
ONCE展览

经典应用

水瓶印刷
医用管印刷
桶状品丝印
玻璃品丝印
瓶状化妆品印刷

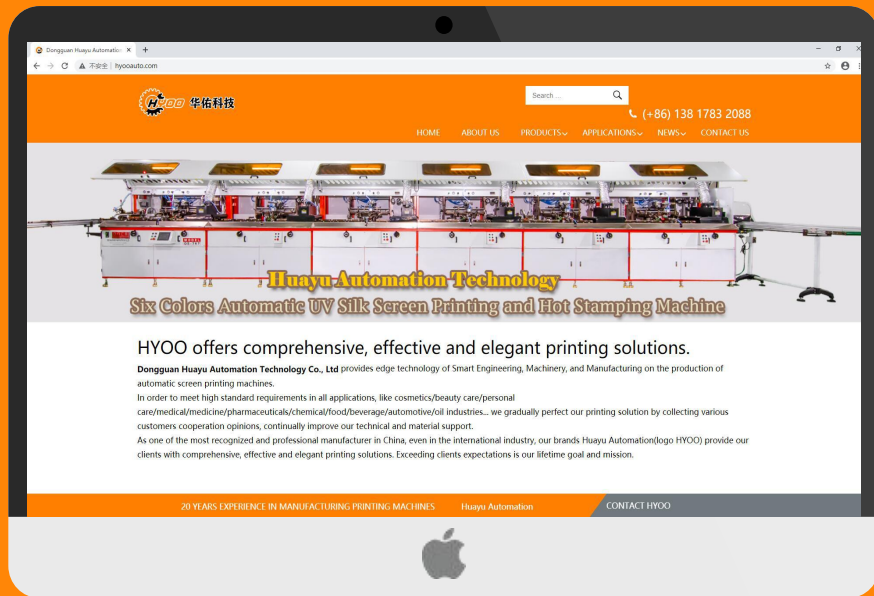

热销产品

圆柱品丝印机
瓶状品丝印机
桶状品丝印机
平面品丝印机
管状品丝印机
烫金机

选安色, 更出色
CHOOSE ONCE, TRUST FOREVER

社交网络

关注我们，收获一个自动化印刷设备解决方案的新世界

 www.hyooauto.com, www.oncemachinery.com, www.oncemachine.com

 www.once-machine.com, www.onceprinter.com, <https://oncemachinery.blogspot.com/>

 <https://www.linkedin.com/in/oncemachinery/>

 <https://twitter.com/OnceMachinery>

 <https://www.youtube.com/c/ONCEMachinery>

 <https://www.pinterest.com/oncemachinery/>

 sales@oncemachinery.com, info@oncemachinery.com

Dongguan Huayu Automation Technology Co., Ltd.
东莞市华佑自动化科技有限公司
Dongguan ONCE Machinery Manufacturing Co, Ltd.
东莞市安色机械制造有限公司

地址: 广东省东莞市常平镇常横路144-168号A栋
电话: 0769 8298 7188 传真: 0769 8298 5899